

TEAC

SERVICE MANUAL

(For Europe Use)

MODEL DV-3000

CAUTION : Before servicing this chassis, read the "PRODUCT SAFETY SERVICE FOR VIDEO PRODUCTS" section on page 2 of this manual.

DVD and CD PLAYER



SPECIFICATIONS

DVD VIDEO PLAYER

Signal system	PAL/AUTO/NTSC
Laser	Wavelength 650nm
Frequency response	20Hz to 20kHz
Signal/Noise ratio	≥85dB
Audio distortion+noise	≤-80dB(1kHz)
Channel separation	≥90dB(1kHz)
Dynamic range	≥85dB(1kHz)

OUTPUTS

Video outputs	1.0V(p-p), 75ohm, negative sync.
S-video outputs	(Y)1.0V(p-p), (C)0.286V(p-p) 75ohm, negative sync.
Audio outputs (digital audio)	0.5V(p-p), 75ohm
Audio outputs (analog audio)	2.0Vrms(1KHz,0.8dB), 10Kohm

GENERAL

Power supply	AC120V, 60Hz
Power consumption	<20W
Dimensions	435 x 95 x 280 (mm)
Weight	Around 4kgs

CONTENTS

SERVICE PRECAUTIONS	2-3
LOCATION OF CONTROLS	4-6
BLOCK DIAGRAMS	7
ELECTRICAL TROUBLE SHOOTING GUIDE	8-18
PRINTED CIRCUIT	20-25
EXPLODED VIEW/PARTS LIST(CABINET)	26
REPLACEMENT PARTS LIST	27-28

PRODUCT SAFETY SERVICING GUIDELINES FOR VIDEO PRODUCTS

CAUTION: DO NOT ATTEMPT TO MODIFY THIS PRODUCT IN ANY WAY AND NEVER PERFORM CUSTOMIZED INSTALLATIONS WITHOUT MANUFACTURER'S APPROVAL. UNAUTHORIZED MODIFICATIONS WILL NOT ONLY VOID THE WARRANTY, BUT MAY LEAD TO YOUR BEING LIABLE FOR ANY RESULTING PROPERTY DAMAGE OR USER INJURY.

SERVICE WORK SHOULD BE PERFORMED ONLY AFTER YOU ARE THOROUGHLY FAMILIAR WITH ALL OF THE FOLLOWING SAFETY CHECKS AND SERVICING GUIDELINES. TO DO OTHERWISE, INCREASES THE RISK OF POTENTIAL HAZARDS AND INJURY TO THE USER.

WHILE SERVICING, USE AN ISOLATION TRANSFORMER FOR PROTECTION FROM A.C. LINE SHOCK.

SAFETY CHECKS

AFTER THE ORIGINAL SERVICE PROBLEM HAS BEEN CORRECTED, A CHECK SHOULD BE MADE OF THE FOLLOWING.

SUBJECT: FIRE & SHOCK HAZARD

1. BE SURE THAT ALL COMPONENTS ARE POSITIONED IN SUCH A WAY AS TO AVOID POSSIBILITY OF ADJACENT COMPONENT SHORTS. THIS IS ESPECIALLY IMPORTANT ON THOSE MODULES WHICH ARE TRANSPORTED TO AND FROM THE REPAIR SHOP.
2. NEVER RELEASE A REPAIR UNLESS ALL PROTECTIVE DEVICES SUCH AS INSULATORS, BARRIERS, COVERS, SHIELDS, STRAIN RELIEFS, POWER SUPPLY CORDS, AND OTHER HARDWARE HAVE BEEN REINSTALLED PER ORIGINAL DESIGN. BE SURE THAT THE SAFETY PURPOSE OF THE POLARIZED LINE PLUG HAS NOT BEEN DEFEATED.
3. SOLDERING MUST BE INSPECTED TO DISCOVER POSSIBLE COLD SOLDER JOINTS, SOLDER SPLASHES OR SHARP SOLDER POINTS. BE CERTAIN TO REMOVE ALL LOOSE FOREIGN PARTICLES.
4. CHECK FOR PHYSICAL EVIDENCE OF DAMAGE OR DETERIORATION TO PARTS AND COMPONENTS, FOR FRAYED LEADS AND DAMAGED INSULATION (INCLUDING A.C. CORD), AND REPLACE IF NECESSARY FOLLOW ORIGINAL LAYOUT, LEAD LENGTH AND DRESS.
5. NO LEAD OR COMPONENT SHOULD TOUCH A RECEIVING TUBE OR A RESISTOR RATED AT 1 WATT OR MORE. LEAD TENSION AROUND PROTRUDING METAL SURFACES MUST BE AVOIDED.
6. ALL CRITICAL COMPONENTS SUCH AS FUSES, FLAMEPROOF RESISTORS, CAPACITORS, ETC. MUST BE REPLACED WITH EXACT FACTORY TYPES, DO NOT USE REPLACEMENT COMPONENTS OTHER THAN THOSE SPECIFIED OR MAKE UNRECOMMENDED CIRCUIT MODIFICATIONS.
7. AFTER RE-ASSEMBLY OF THE SET, ALWAYS PERFORM AN A.C. LEAKAGE TEST ON ALL EXPOSED METALLIC PARTS OF THE CABINET, (THE CHANNEL SELECTOR KNOB, ANTENNA TERMINALS, HANDLE AND SCREWS) TO BE SURE THE SET IS SAFE TO OPERATE WITHOUT DANGER OF ELECTRICAL SHOCK. DO NOT USE A LINE ISOLATION TRANSFORMER DURING THIS TEST, MAKE SURE TO USE AN A.C. VOLTMETER, HAVING 5000 OHMS PER VOLT OR MORE SENSITIVITY, IN THE FOLLOWING MANNER; CONNECT A 1500 OHMS 10 WATT RESISTOR, PARALLELED BY A .15 MFD. 150V A.C. TYPE CAPACITOR BETWEEN A KNOWN GOOD EARTH GROUND (WATER PIPE, CONDUIT, ETC.) AND THE EXPOSED METALLIC PARTS, ONE AT A TIME. MEASURE THE A.C. VOLTAGE ACROSS THE COMBINATION OF 1500 OHM RESISTOR AND .15 MFD CAPACITOR. REVERSE THE A.C. PLUG AND REPEAT A.C. ANY VOLTAGE MEASUREMENTS FOR EACH EXPOSED METALLIC PART. VOLTAGE MEASURED MUST NOT EXCEED 75 VOLTS R.M.S. THIS CORRESPONDS TO 0.5 MILLIAMP A.C. ANY VALUE EXCEEDING THIS LIMIT CONSTITUTES A POTENTIAL SHOCK HAZARD AND MUST BE CORRECTED IMMEDIATELY.

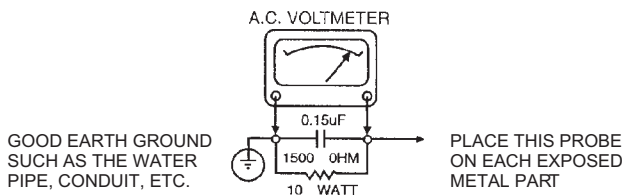

SUBJECT GRAPHIC SYMBOLS

 THE LIGHTNING FLASH WITH APROWHEAD SYMBOL, WITHIN AN EQUILATERAL TRIANGLE, IS INTENDED TO ALERT THE SERVICE PERSONNEL TO THE PRESENCE OF UNINSULATED "DANGEROUS VOLTAGE" THAT MAY BE OF SUFFICIENT MAGNITUDE TO CONSTITUTE A RISK OF ELECTRIC SHOCK.

 THE EXCLAMATION POINT WITHIN AN EQUILATERAL TRIANGLE IS INTENDED TO ALERT THE SERVICE PERSONNEL TO THE PRESENCE OF IMPORTANT SAFETY INFORMATION IN SERVICE LITERATURE.

SUBJECT: X-RADIATION

1. BE SURE PROCEDURES AND INSTRUCTIONS TO ALL SERVICE PERSONNEL COVER THE SUBJECT OF X-RADIATION. THE ONLY POTENTIAL SOURCE OF X-RAYS IN CURRENT T.V. RECEIVERS IS THE PICTURE TUBE. HOWEVER, THIS TUBE DOES NOT EMIT X-RYS WHEN THE HIGH VOLTAGE IS AT THE FACTORY SPECIFIED LEVEL. THE PROPER VALUE IS GIVEN IN THE APPLICABLE SCHEMATIC. OPERATION AT HIGHER VOLTAGES MAY CAUSE A FAILURE OF THE PICTURE TUBE OR HIGH VOLTAGE SUPPLY AND, UNDER CERTAIN CIRCUMSTANCES, MAY PRODUCE RADIATION IN EXCESS OF DESIRABLE LEVELS.
2. ONLY FACTORY SPECIFIED C.R.T ANODE CONNECTORS MUST BE USED. DEGAUSSING SHIELDS ALSO SERVE AS AN X-RAY SHIELD IN COLOR SETS, ALWAYS RE-INSTALL THEM.
3. IT IS ESSENTIAL THAT SERVICE PERSONNEL HAVE AVAILABLE AN ACCURATE AND RELIABLE HIGH VOLTAGE METER. THE CALIBRATION OF THE METER SHOULD BE CHECKED PERIODICALLY AGAINST A REFERENCE STANDARD, SUCH AS THE ONE AVAILABLE AT YOUR DISTRIBUTOR.
4. WHEN THE HIGH VOLTAGE CIRCUITRY IS OPERATING PROPERLY, THERE IS NO POSSIBILITY OF AN X-RADIATION PROBLEM. EVERY TIME A COLOR CHASSIS IS SERVICED, THE BRIGHTNESS SHOULD BE RUN UP AND DOWN WHILE MONITORING THE HIGH VOLTAGE WITH A METER TO BE CERTAIN THAT THE HIGH VOLTAGE DOES NOT EXCEED THE SPECIFIED VALUE AND THAT IT IS REGULATING CORRECTLY. WE SUGGEST THAT YOU AND YOUR SERVICE ORGANIZATION REVIEW TEST PROCEDURES SO THAT VOLTAGE REGULATION IS ALWAYS CHECKED AS A STANDARD SERVICING PROCEDURE AND THAT THE HIGH VOLTAGE READING BE RECORDED ON EACH CUSTOMER'S INVOICE.
5. WHEN TROUBLESHOOTING AND MAKING TEST MEASUREMENTS IN A PRODUCT WITH A PROBLEM OF EXCESSIVE HIGH VOLTAGE AVOID BEING UNNECESSARILY CLOSE TO THE PICTURE TUBE AND THE HIGH VOLTAGE SUPPLY DO NOT OPERATE THE PRODUCT LONGER THAN IT IS NECESSARY TO LOCATE THE CAUSE OF EXCESSIVE VOLTAGE.
6. REFER TO HV. B+ AND SHUTDOWN ADJUSTMENT PROCEDURES DESCRIBED IN THE APPROPRIATE SCHEMATIC AND DIAGRAMS(WHERE USED).

SUBJECT: IMPLOSION

1. ALL DIRECT VIEWED PICTURE TUBES ARE EQUIPPED WITH AN INTEGRAL IMPLOSION PROTECTION SYSTEM, BUT CARE SHOULD BE TAKEN TO AVOID DAMAGE DURING INSTALLATION, AVOID SCRATCHING THE TUBE. IF SCRATCHED REPLACE IT.
2. USE ONLY RECOMMENDED FACTORY REPLACEMENT TUBES.

SUBJECT: TIPS ON PROPER INSTALLATION

1. NEVER INSTALL ANY PRODUCT IN A CLOSED-IN RECESS. CUBBYHOLE OR CLOSELY FITTING SHELF SPACE, OVER OR CLOSE TO HEAT DUCT, OR IN THE PATH OF HEATED AIR FLOW.
2. AVOID CONDITIONS OF HIGH HUMIDITY SUCH AS: OUTDOOR PATIO INSTALLATIONS WHERE DEW IS A FACTOR, NEAR STEAM RADIATORS WHERE STEAM LEAKAGE IS A FACTOR, ETC.
3. AVOID PLACEMENT WHERE DRAPERIES MAY OBSTRUCT REAR VENTING. THE CUSTOMER SHOULD ALSO AVOID THE USE OF DECORATIVE SCARVES OR OTHER COVERINGS WHICH MIGHT OBSTRUCT VENTILATION.
4. WALL AND SHELF MOUNTED INSTALLATIONS USING A COMMERCIAL MOUNTING KIT, MUST FOLLOW THE FACTORY APPROVED MOUNTING INSTRUCTIONS. A PRODUCT MOUNTED TO A SHELF OR PLATFORM MUST RETAIN ITS ORIGINAL FEET (OR THE EQUIVALENT THICKNESS IN SPACERS) TO PROVIDE ADEQUATE AIR FLOW ACROSS THE BOTTOM. BOLTS OR SCREWS USED FOR FASTENERS MUST NOT TOUCH ANY PARTS OR WIRING. PERFORM LEAKAGE TEST ON CUSTOMIZED INSTALLATIONS.
5. CAUTION CUSTOMERS AGAINST THE MOUNTING OF A PRODUCT ON SLOPING SHELF OR A TILTED POSITION, UNLESS THE PRODUCT IS PROPERLY SECURED.
6. A PRODUCT ON A ROLL-ABOUT CART SHOULD BE STABLE ON ITS MOUNTING TO THE CART CAUTION THE CUSTOMER ON THE HAZARDS OF TRYING TO ROLL A CART WITH SMALL CASTERS ACROSS THRESHOLDS OR DEEP PILE CARPETS.
7. CAUTION CUSTOMERS AGAINST THE USE OF A CART OR STAND WHICH HAS NOT BEEN LISTED BY UNDERWRITERS LABORATORIES, INC. FOR USE WITH THEIR SPECIFIC MODEL OF TELEVISION RECEIVER OR GENERICALLY APPROVED FOR USE WITH TV'S OF THE SAME OR LARGER SCREEN SIZE.
8. CAUTION CUSTOMERS AGAINST THE USE OF EXTENSION CORDS. EXPLAIN THAT A FOREST OF EXTENSIONS SPROUTING FROM A SINGLE OUTLET CAN LEAD TO DISASTROUS CONSEQUENCES TO HOME AND FAMILY.

SERVICING PRECAUTIONS

CAUTION : Before servicing the DVD covered by this service data and its supplements and ADDENDUMS, read and follow the *SAFETY PRECAUTIONS NOTE* : if unforeseen circumstances create conflict between the following servicing precautions and any of the safety precautions in this publications, always follow the safety precautions.

Remember Safety First:

General Servicing Precautions

1. Always unplug the DVD AC power cord from the AC power source before:
 - (1) Removing or reinstalling any component, circuit board, module, or any other assembly.
 - (2) Disconnection or reconnecting any internal electrical plug or other electrical connection.
 - (3) Connecting a test substitute in parallel with an electrolytic capacitor

Caution : A wrong part substitution or incorrect polarity installation of electrolytic capacitors may result in an explosion hazard.
2. Do not spray chemicals on or near this DVD or any of its assemblies.
3. Unless specified otherwise in this service data, clean electrical contacts by applying an appropriate contact cleaning solution to the contacts with a pipe cleaner, cotton-tipped swab, or comparable soft applicator.
Unless specified otherwise in this service data, lubrication of contacts is not required.
4. Do not defeat any plug/socket B+ voltage interlocks with witch instruments covered by this service manual might be equipped.
5. Do not apply AC power to this DVD and/or any of its electrical assemblies unless all solid-state device heat sinks are correctly installed.
6. Always connect test instrument ground lead to the appropriate ground before connection the test instrument positive lead. Always remove the test instrument ground lead last.

Insulation Checking Procedure

Disconnect the attachment plug from the AC outlet and turn the power on. Connect an insulation resistance meter(500V) to the blades of the attachment plug. The insulation resistance between each blade of the attachment plug and accessible conductive parts (Note 1) should be more than 1M ohm.

Note 1 : Accessible Conductive Parts including Metal panels, input terminals, Earphone jacks, etc.

Electrostatically Sensitive (ES) Devices

Some semiconductor (solid state) devices can be damaged easily by static electricity. Such components commonly are called Electrostatically Sensitive (ES) Devices. Examples of typical ES devices are integrated circuits and some field effect transistors and semiconductor chip components.

The following techniques should be used to help reduce the incidence of component damage caused by static electricity.

1. Immediately before handling any semiconductor component or semiconductor-equipped assembly, drain off any electrostatic charge on your body by touching a known earth ground. Alternatively, obtain and wear a commercially available discharging wrist strap device, which should be removed for potential shock reasons prior to applying power to the unit under test.
2. After removing an electrical assembly equipped with ES devices, place the assembly on a conductive surface such as aluminum foil, to prevent electrostatic charge buildup or exposure of the assembly.
3. Use only a GROUNDED-tip soldering iron to solder or unsolder ES devices.
4. Use only an anti-static solder removal device. Some solder removal devices not classified a "anti-static" can generate electrical charges sufficient to damage ES devices.
5. Do not use freon-propelled chemicals. These can generate electrical charge sufficient to damage ES devices.
6. Do not remove a replacement ES device from its protective package until immediately before you are ready to install it. (Most replacement ES devices are packaged with leads electrically shorted together by conductive foam, aluminum foil, or comparable conductive material.)
7. Immediately before removing the protective material from the leads of a replacement ES device, touch the protective material to the chassis or circuit assembly into which the device will be installed.

Caution : Be sure no power is applied to the chassis or circuit, and observe all other safety precautions.

8. Minimize bodily motions when handling unpackaged replacement ES devices. (Normally harmless motion such as the brushing together of your clothes fabric or the lifting of your foot from a carpeted floor can generate static electricity sufficient to damage an ES device.)

PREPARATIONS BEFORE OPERATION

FRONT PANEL

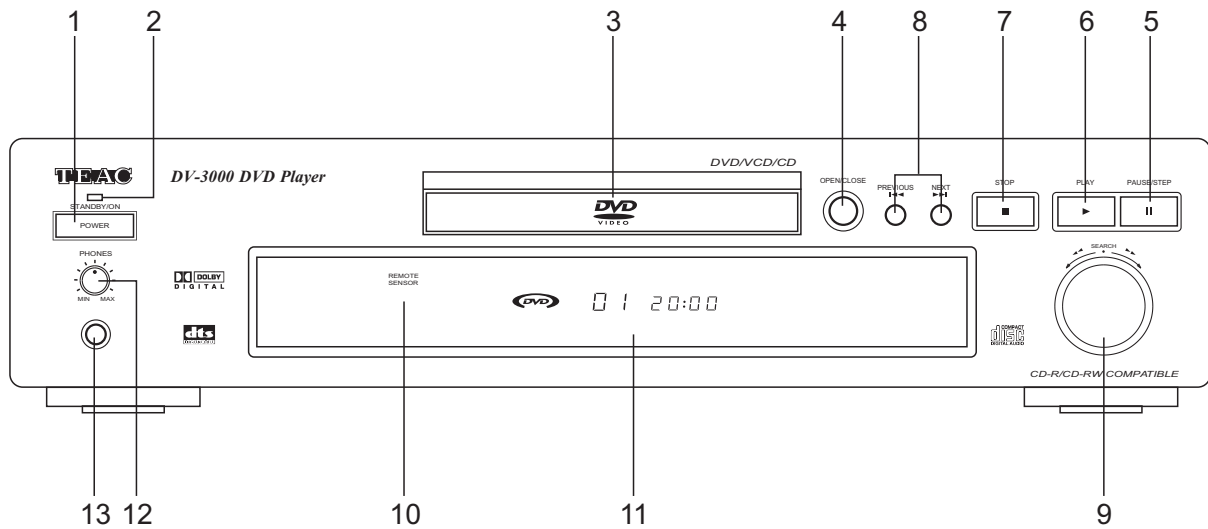

- | | |
|----------------------|-------------------|
| 1. POWER | 8. PREVIOUS/NEXT |
| 2. STANDBY INDICATOR | 9. SEARCH |
| 3. DISC TRAY | 10. REMOTE SENSOR |
| 4. OPEN/CLOSE | 11. DISPLAY |
| 5. PAUSE/STEP | 12. PHONES LEVEL |
| 6. PLAY | 13. PHONES JACK |
| 7. STOP | |

DISPLAY

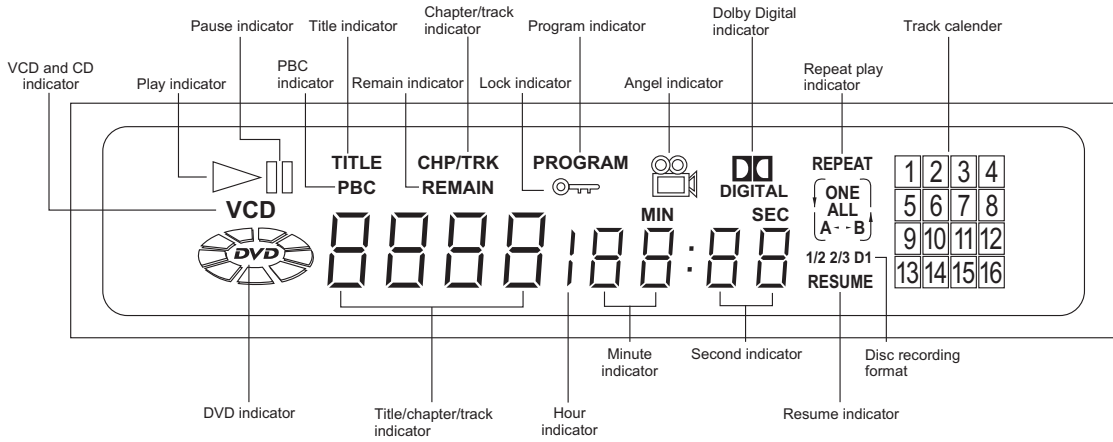

Push **DIMMER**, the brightness of the display is reduced by half, push it once more, the display becomes dark. Push the button again, the display resumes brightness.

REAR PANEL

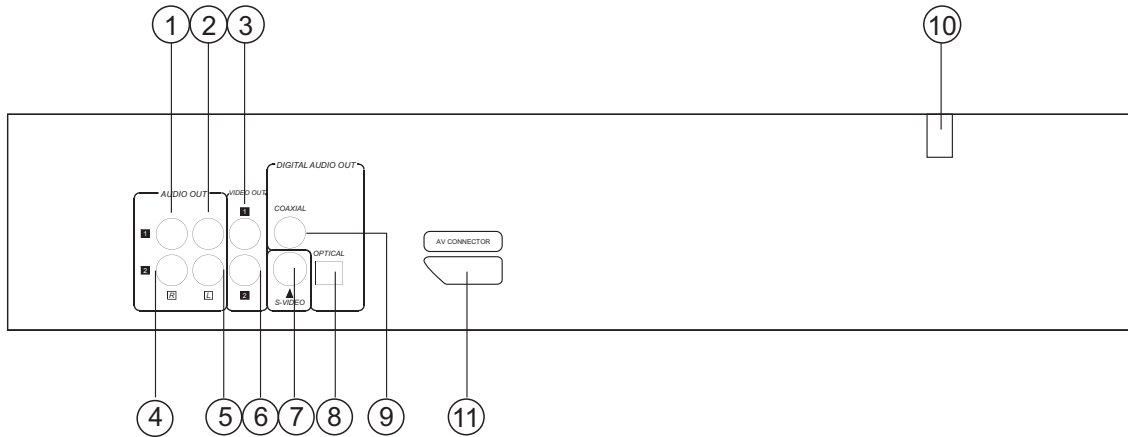

- 1 AUDIO OUT1 R
- 2 AUDIO OUT1 L
- 3 VIDEO OUT1
- 4 AUDIO OUT2 R
- 5 AUDIO OUT2 L

- 6 VIDEO OUT2
- 7 S-VIDEO OUT
- 8 DIGITAL OUT(OPTICAL)
- 9 DIGITAL OUT(COAXIAL)
- 10 POWER SUPPLY CORD
- 11 AV CONNECTOR

NAMES AND LAYOUT OF REMOTE CONTROLS

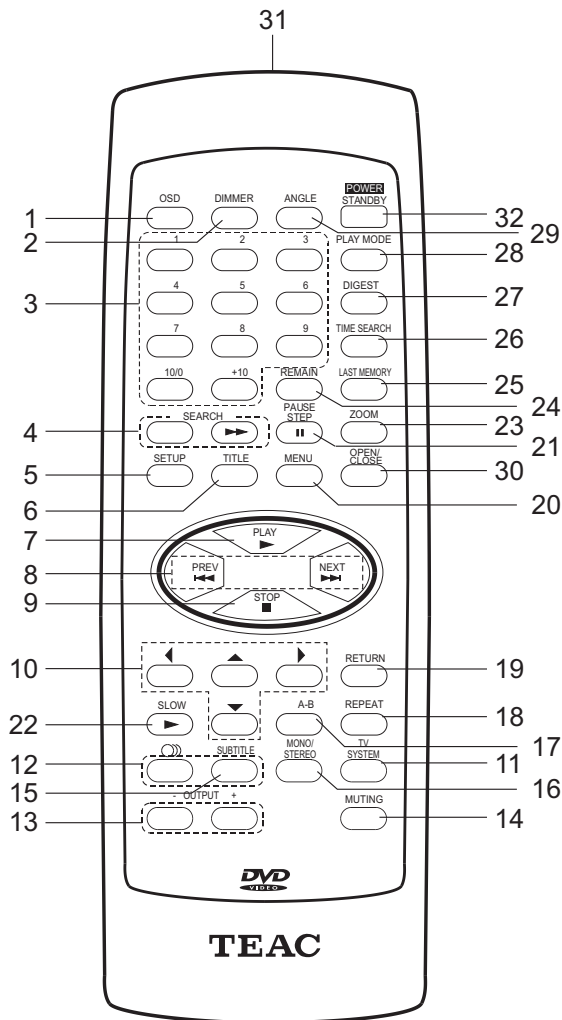

1. OSD
2. DIMMER
3. NUMBER BUTTONS
4. SEARCH
5. SET UP
6. TITLE
7. PLAY
8. PREVIOUS/NEXT
9. STOP
10. DIRECTIONS
11. TV SYSTEM
12. LANGUAGE
13. OUTPUT
14. MUTING
15. SUBTITLE
16. MONO/STEREO
17. A-B REPEAT
18. REPEAT
19. RETURN
20. MENU
21. PAUSE/STEP
22. SLOW
23. ZOOM
24. REMAIN
25. LAST MEMORY
26. TIME SEARCH
27. DIGEST
28. PLAY MODE
29. ANGLE
30. OPEN/CLOSE
31. REMOTE TRANSMITTER
32. POWER

Electrical Trouble Shooting Guide

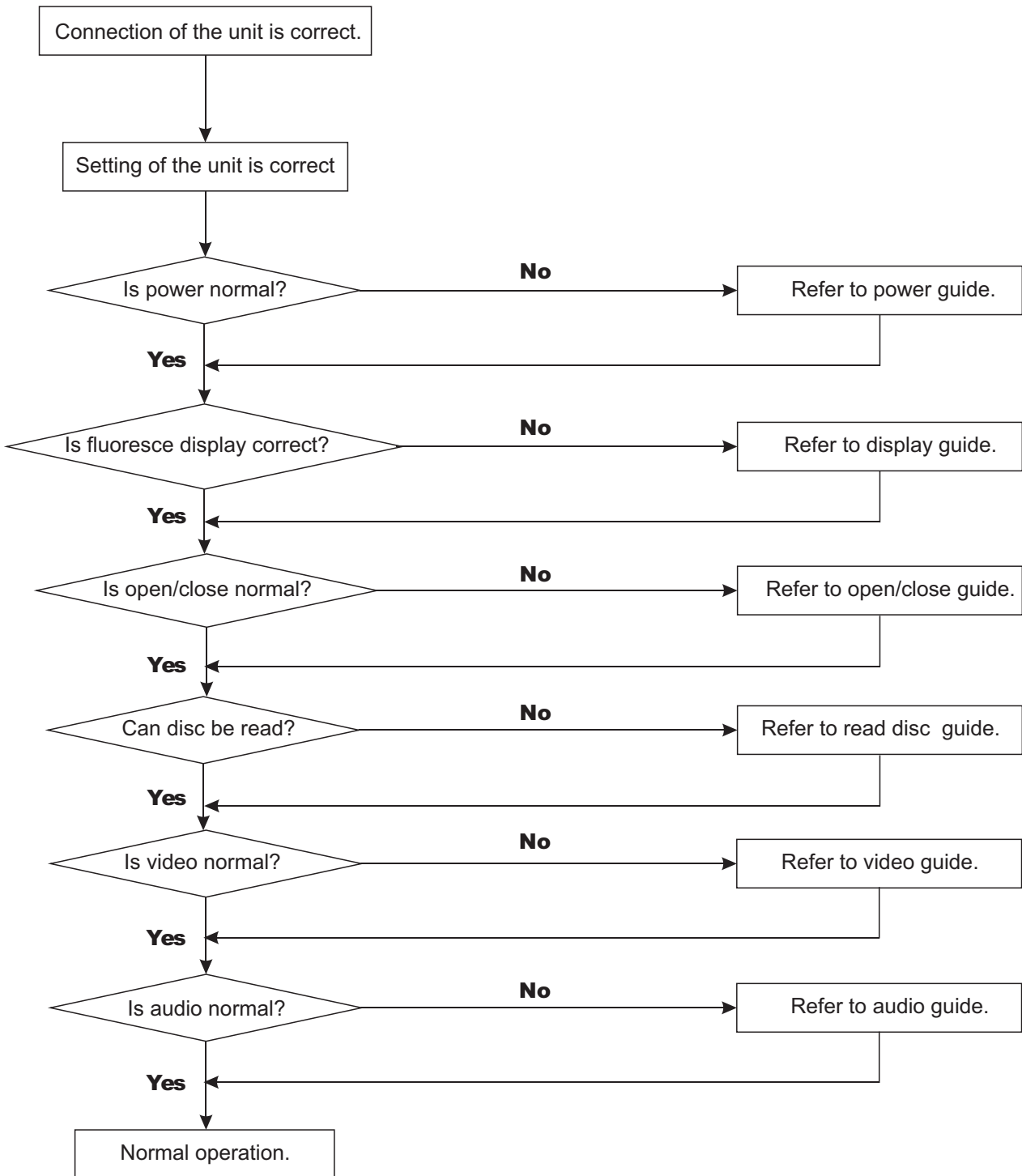

A Power Circuit abnormal

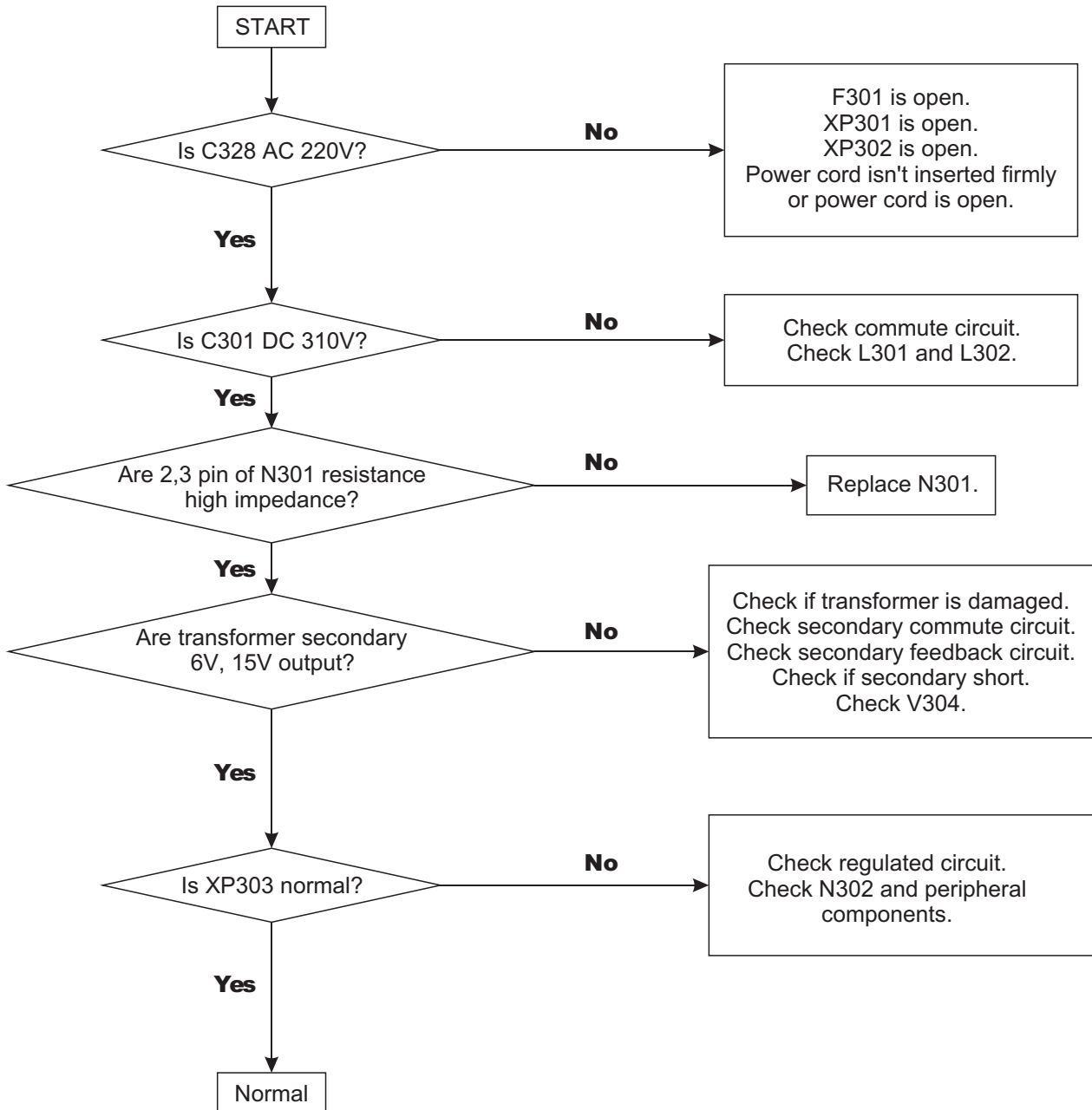

B Display abnormal

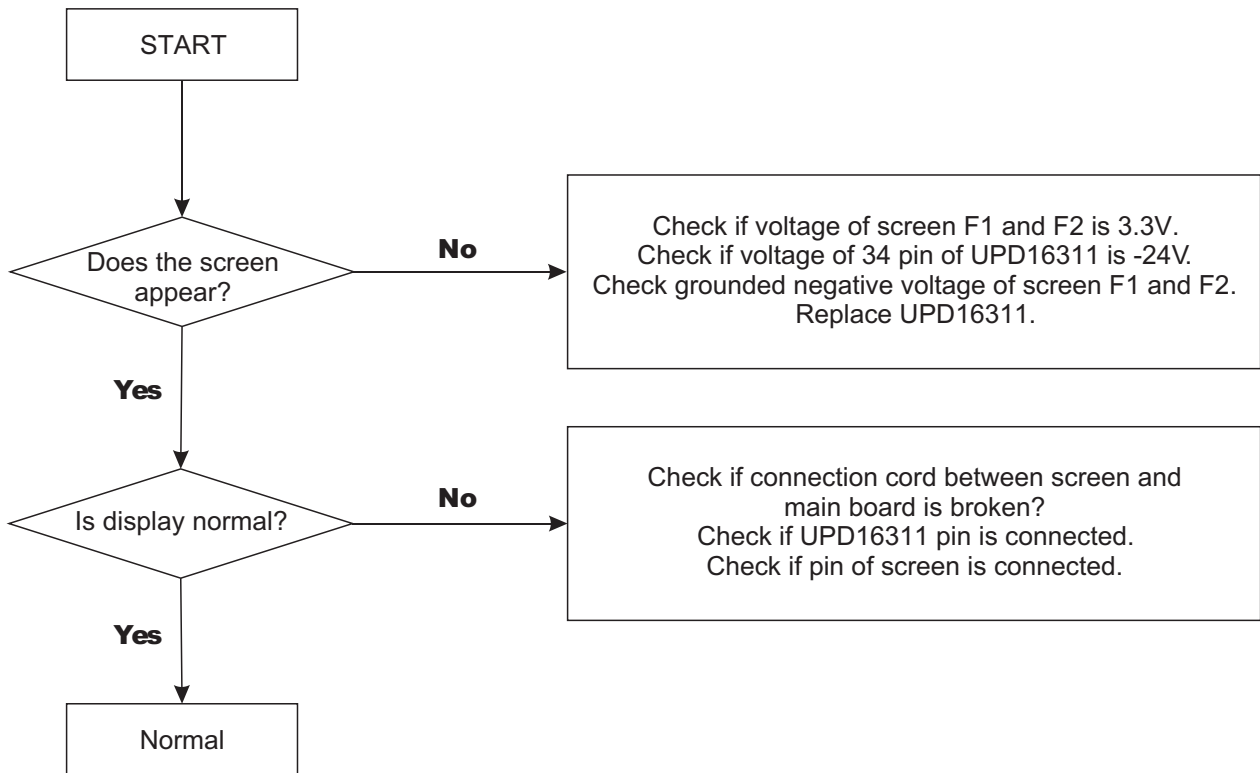

C Open/close abnormal

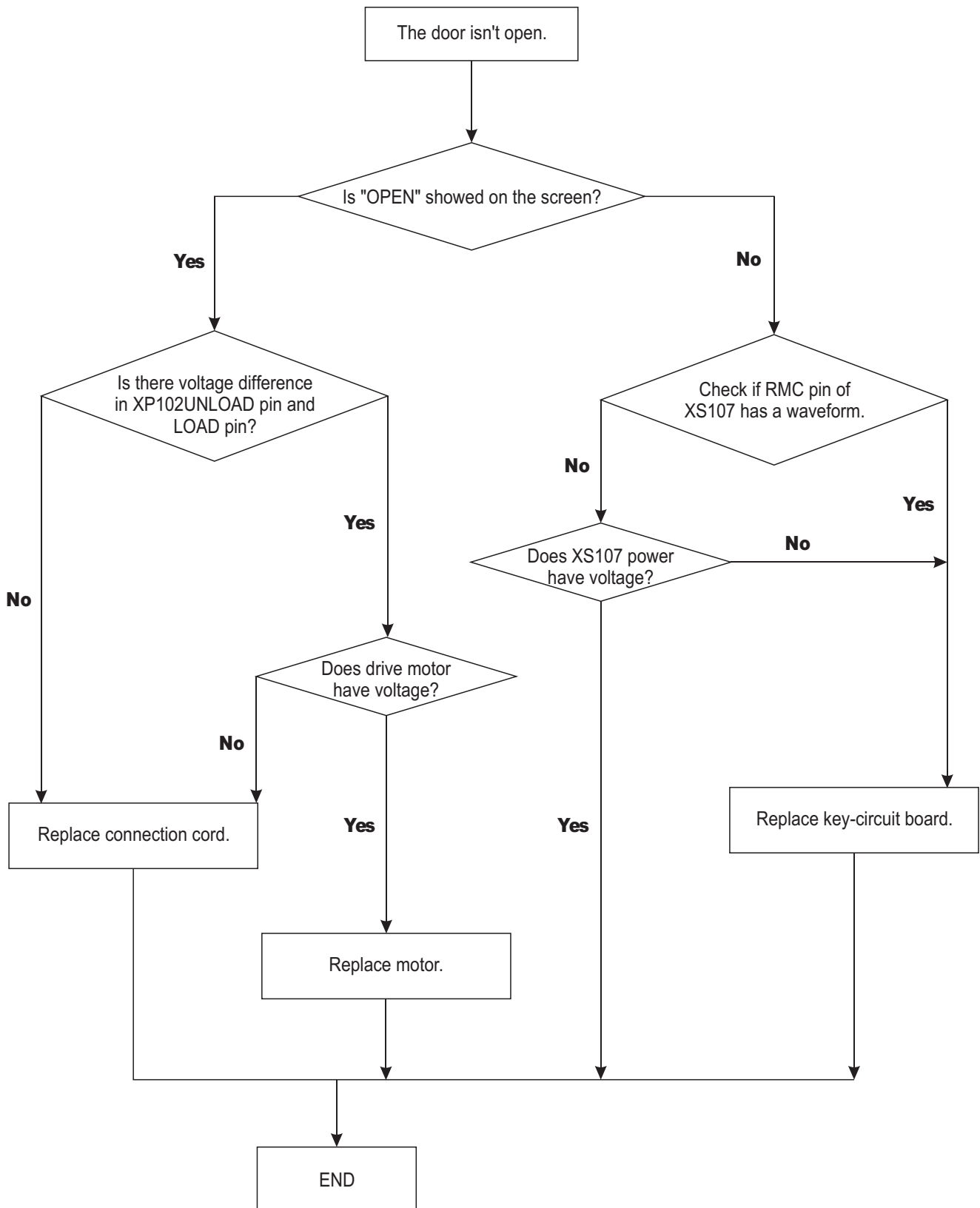

D Read disc abnormal

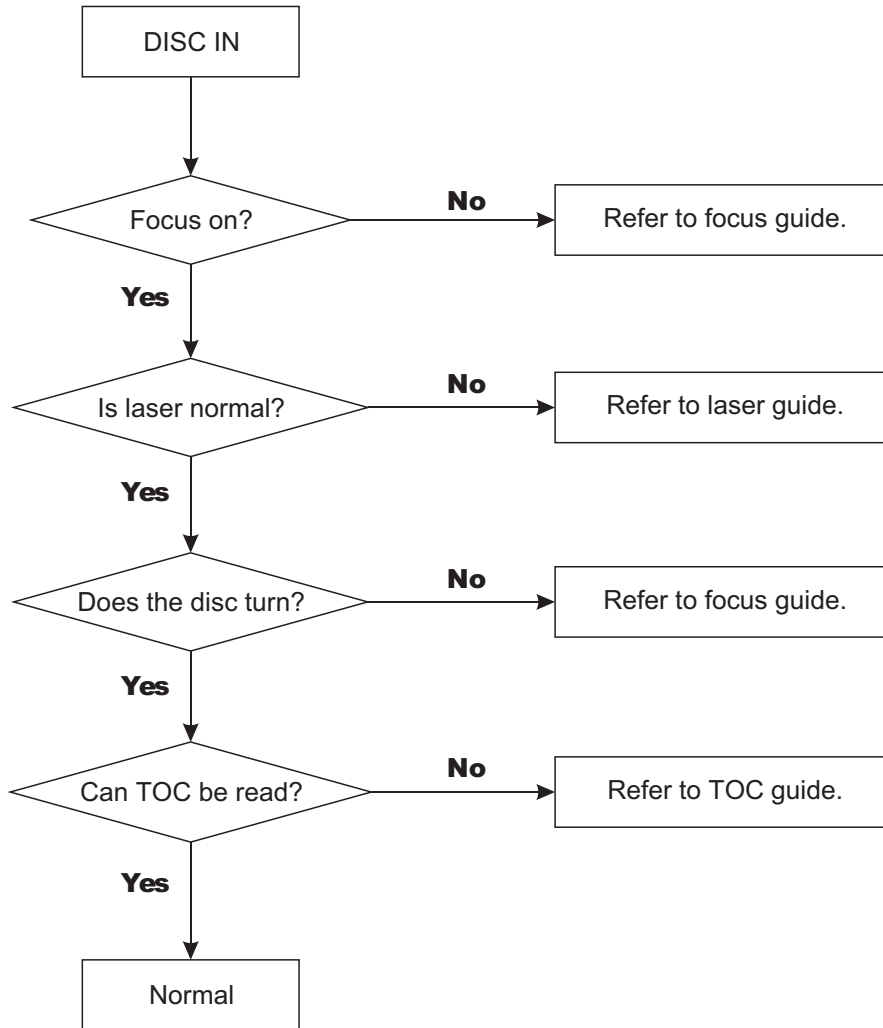

E Video abnormal

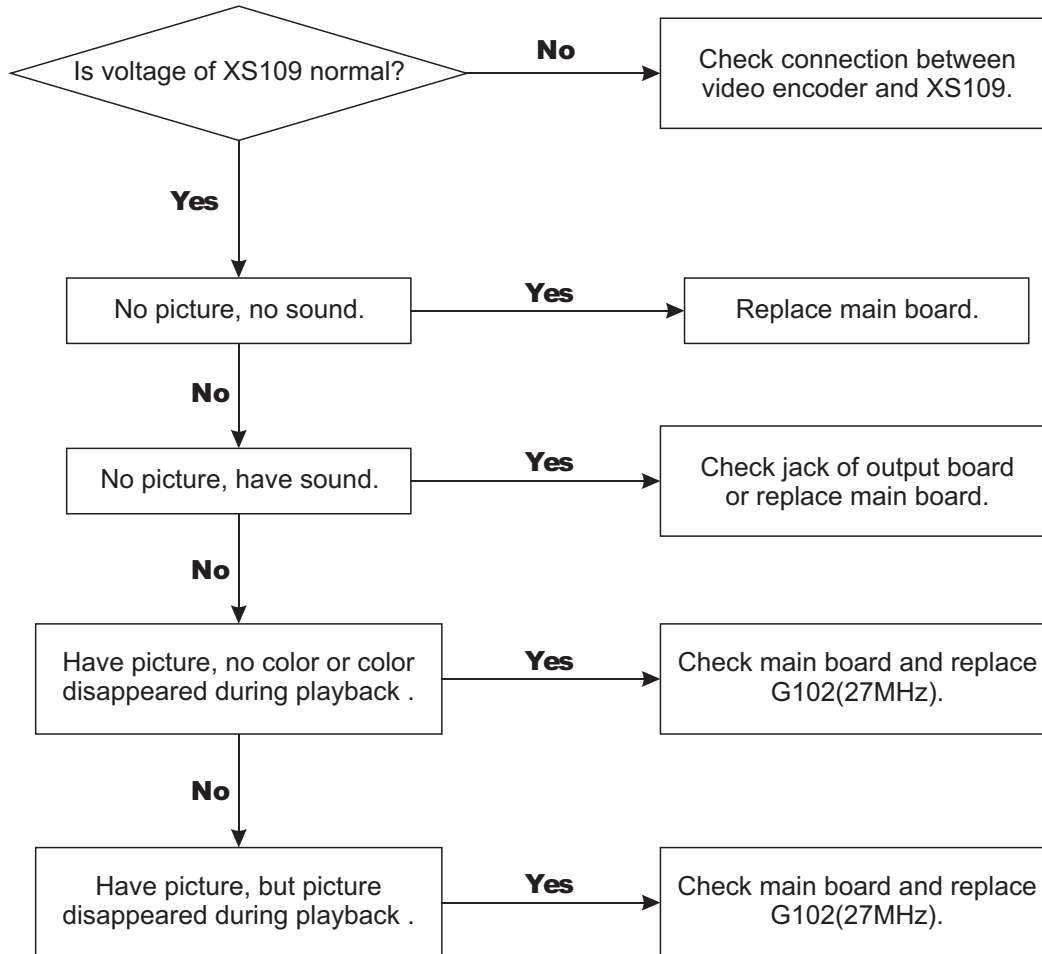

F Audio abnormal

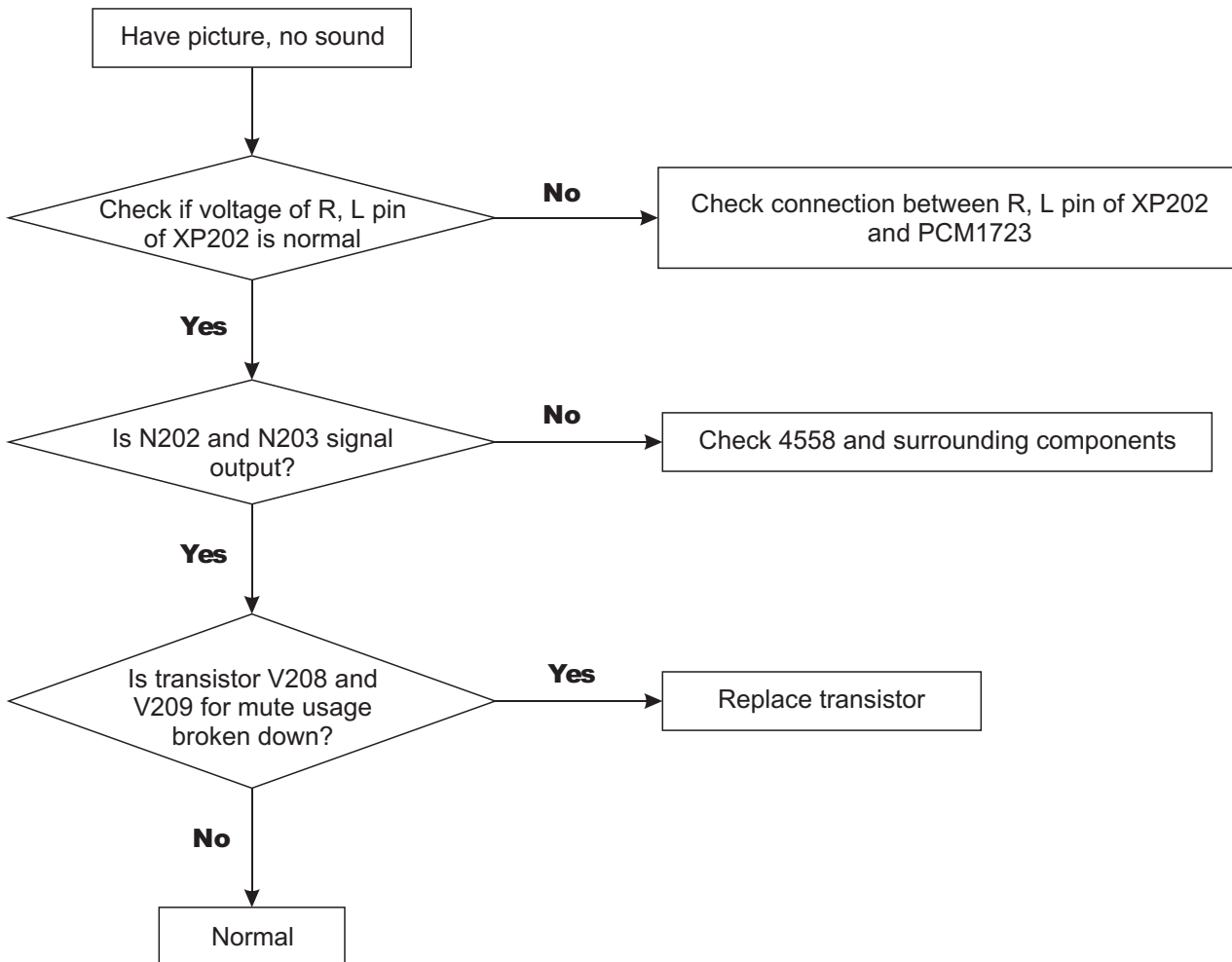

G Focus abnormal

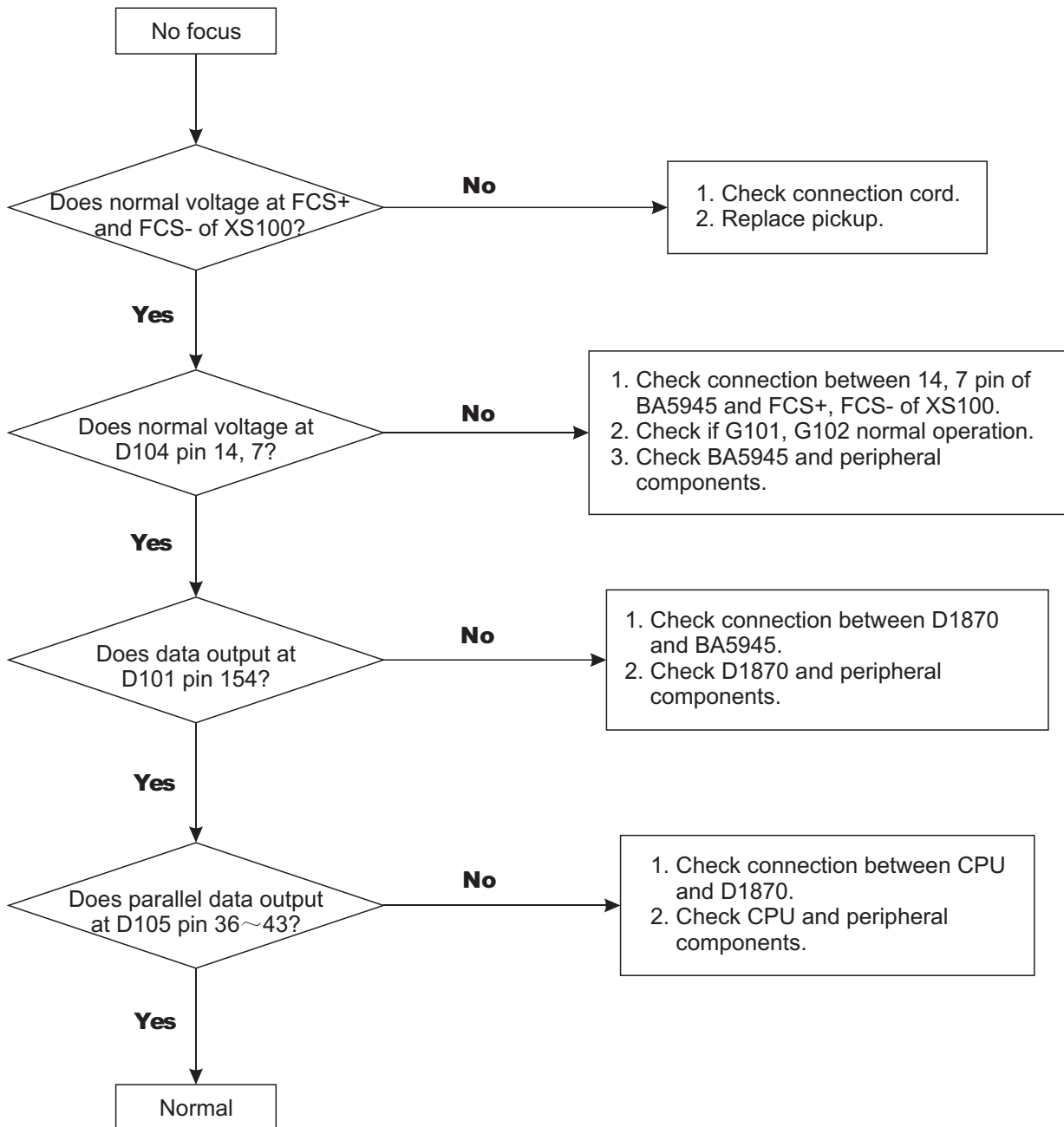

H Laser abnormal

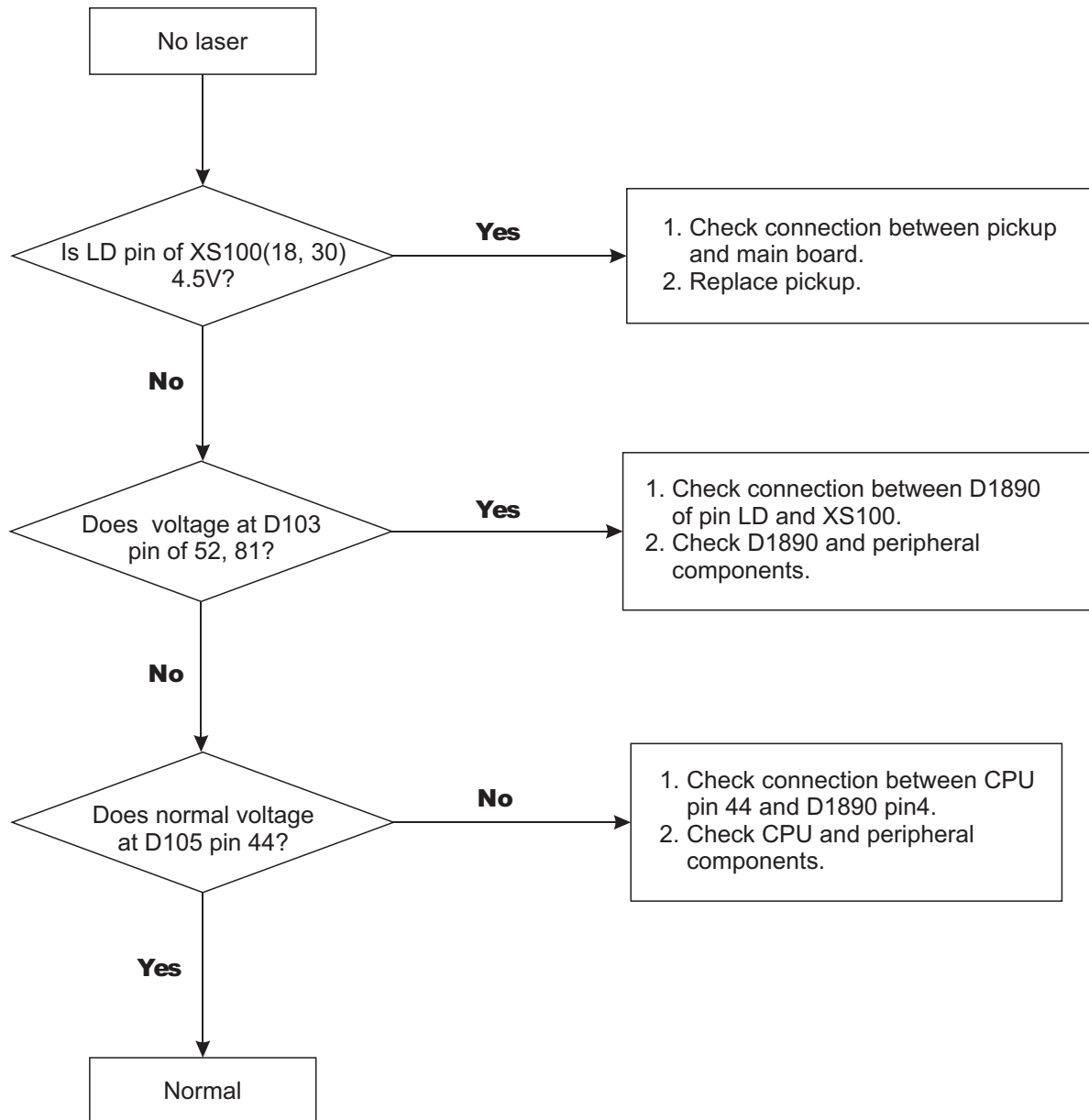

I Turn abnormal

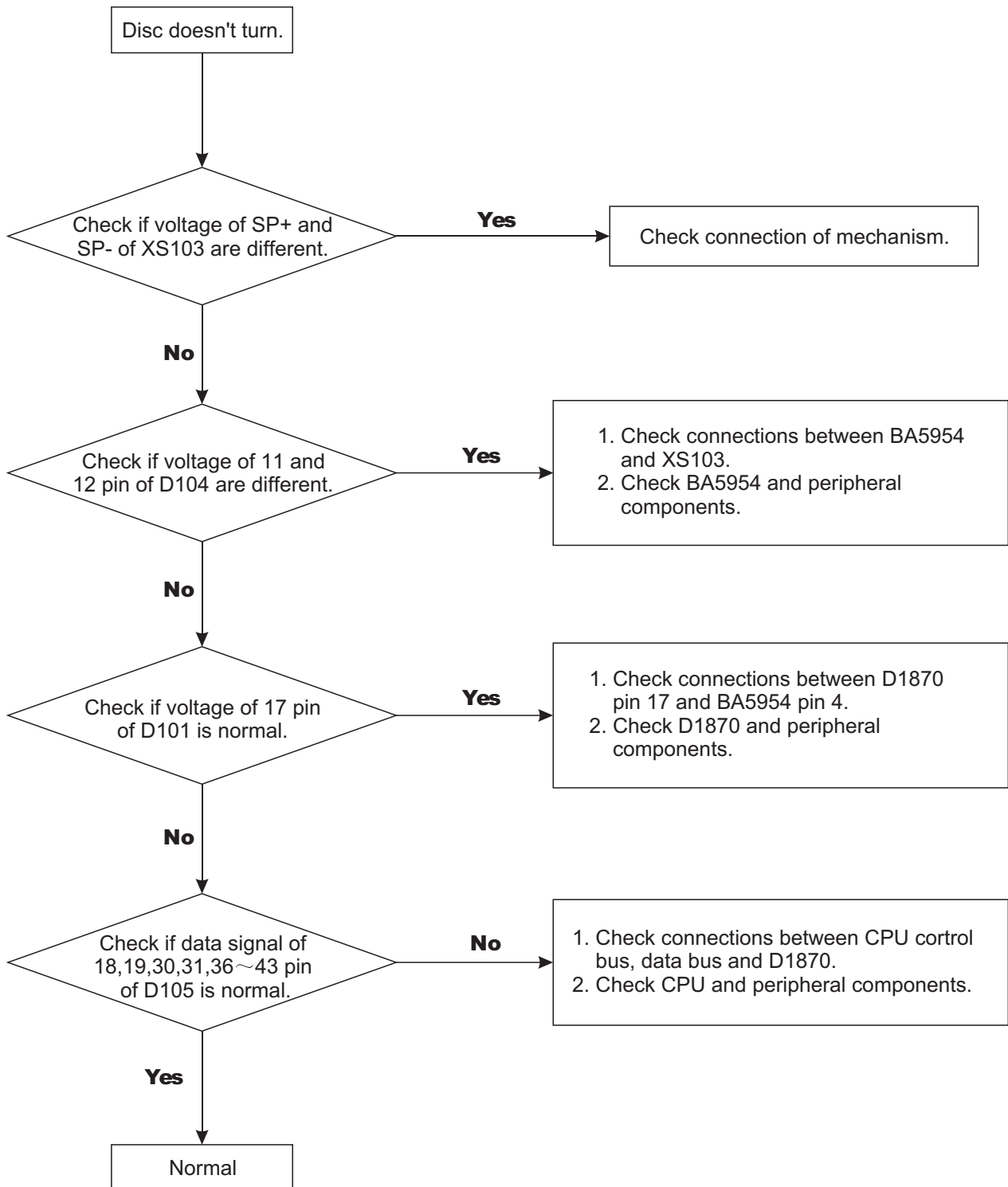

J TOC abnormal

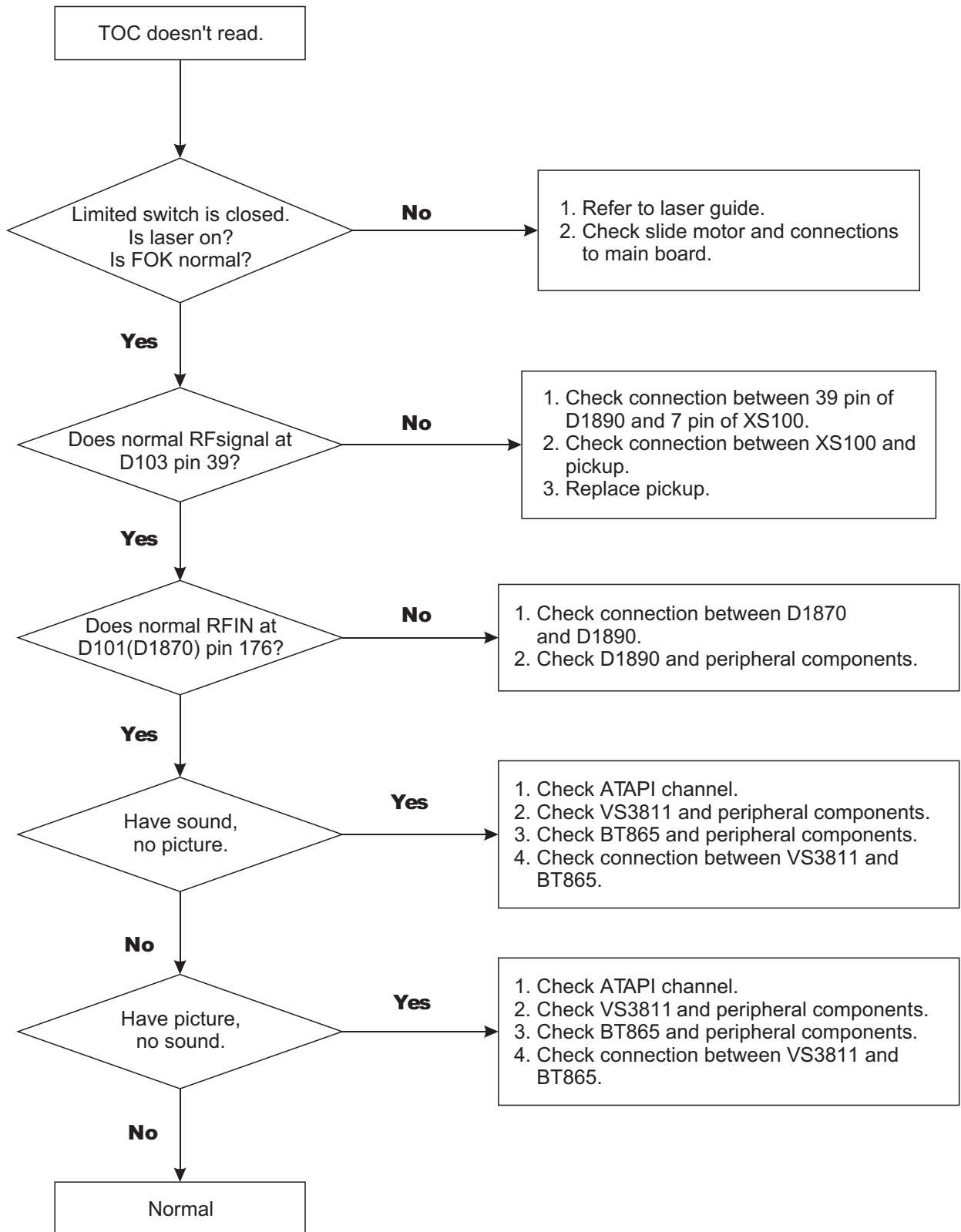

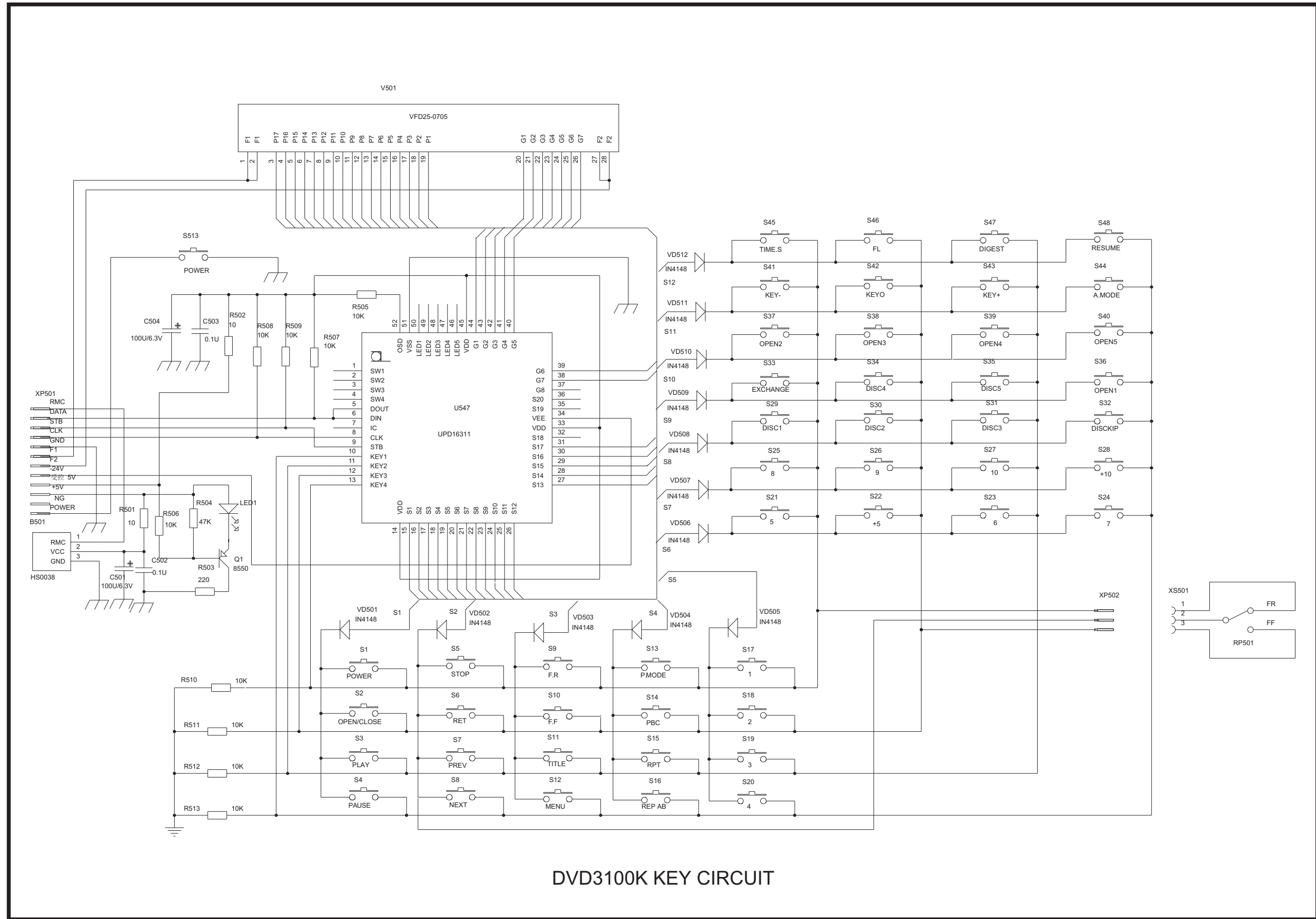

DVD3100K KEY CIRCUIT

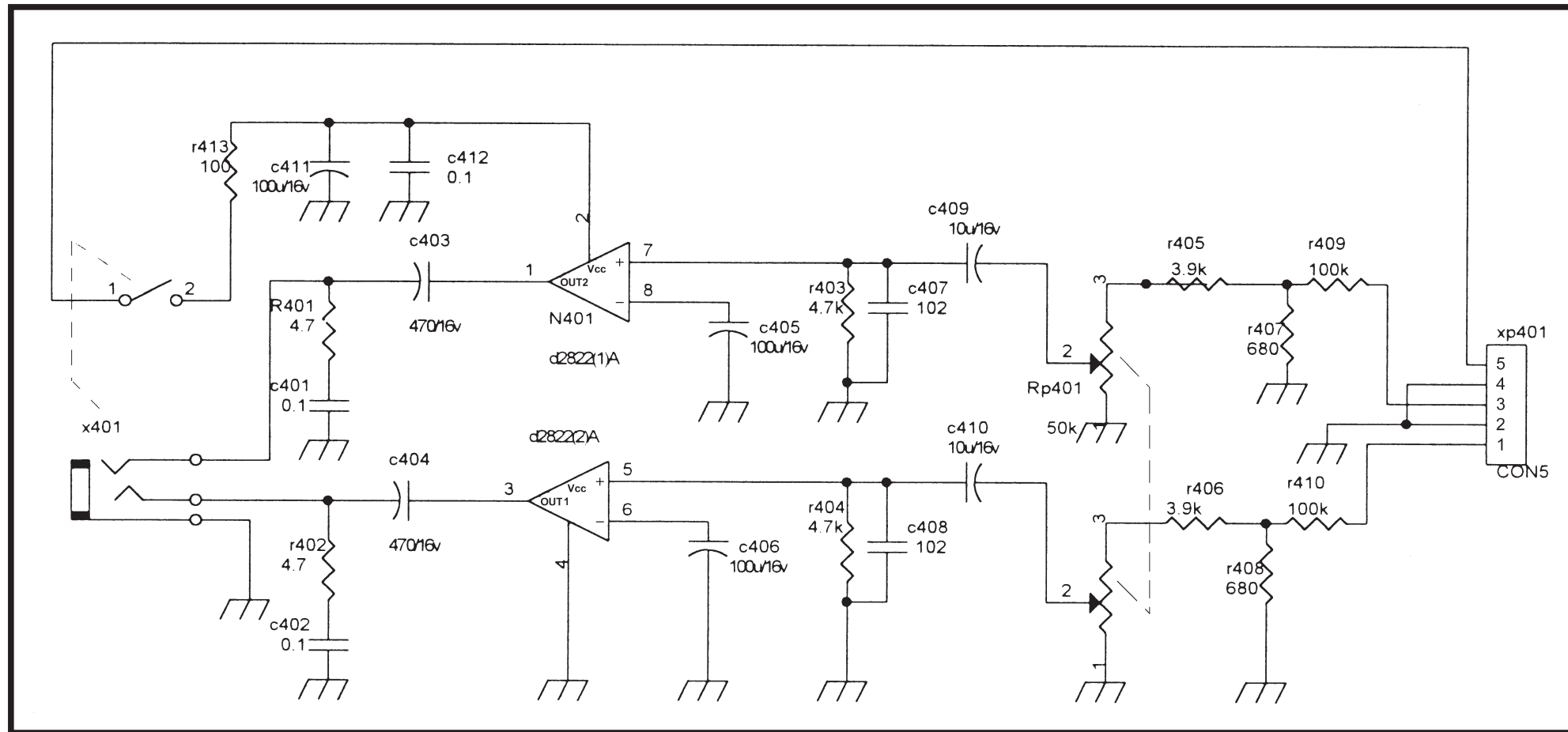

D3000P EARPHONE CIRCUIT

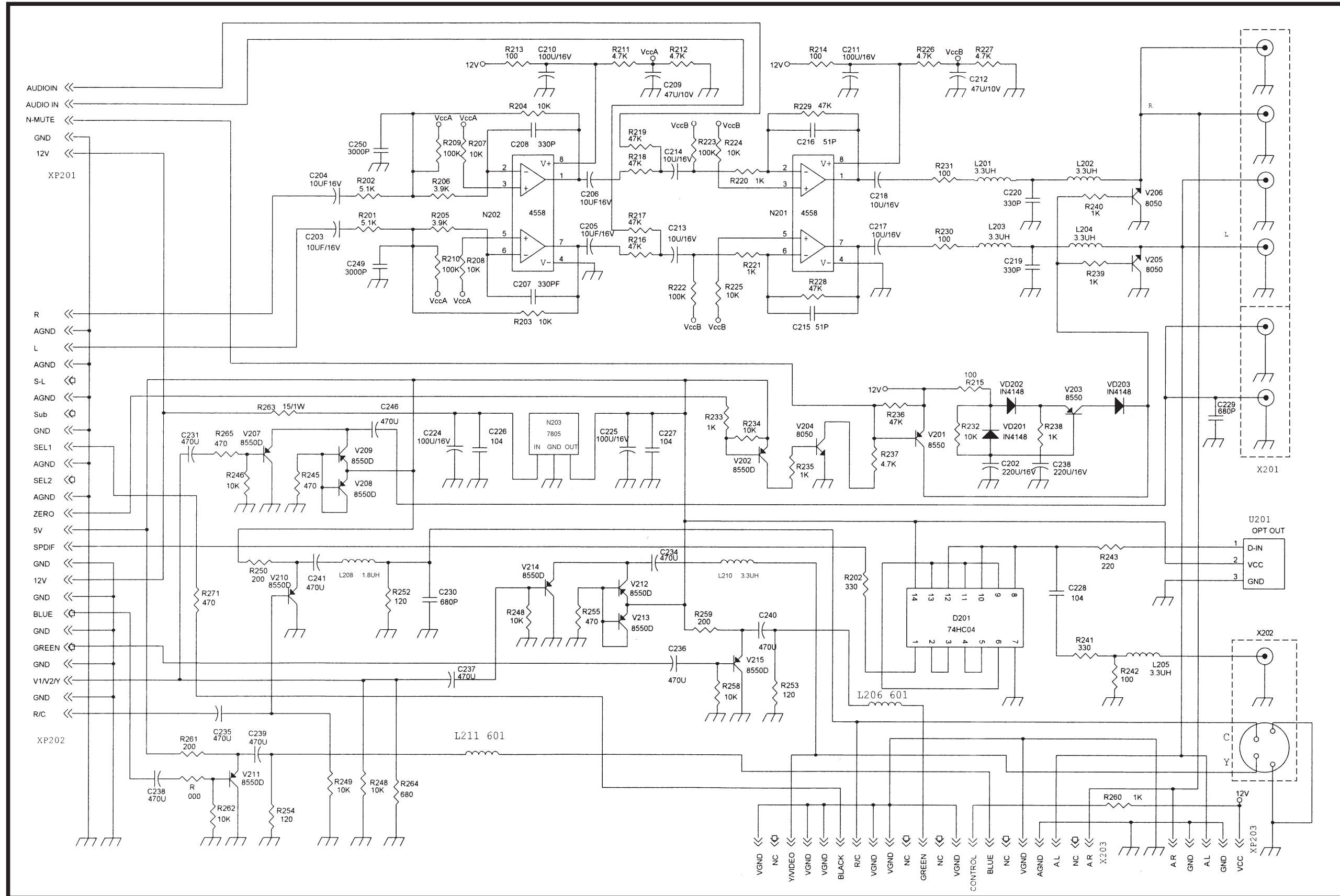

SCART-868-312P OUTPUT CIRCUIT

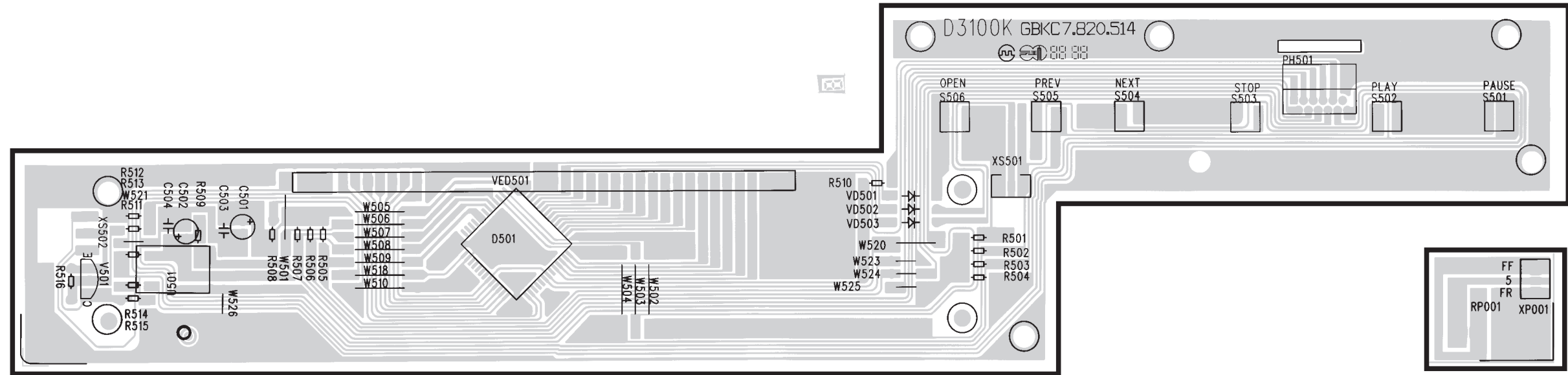

DVD3100K KEYBOARD

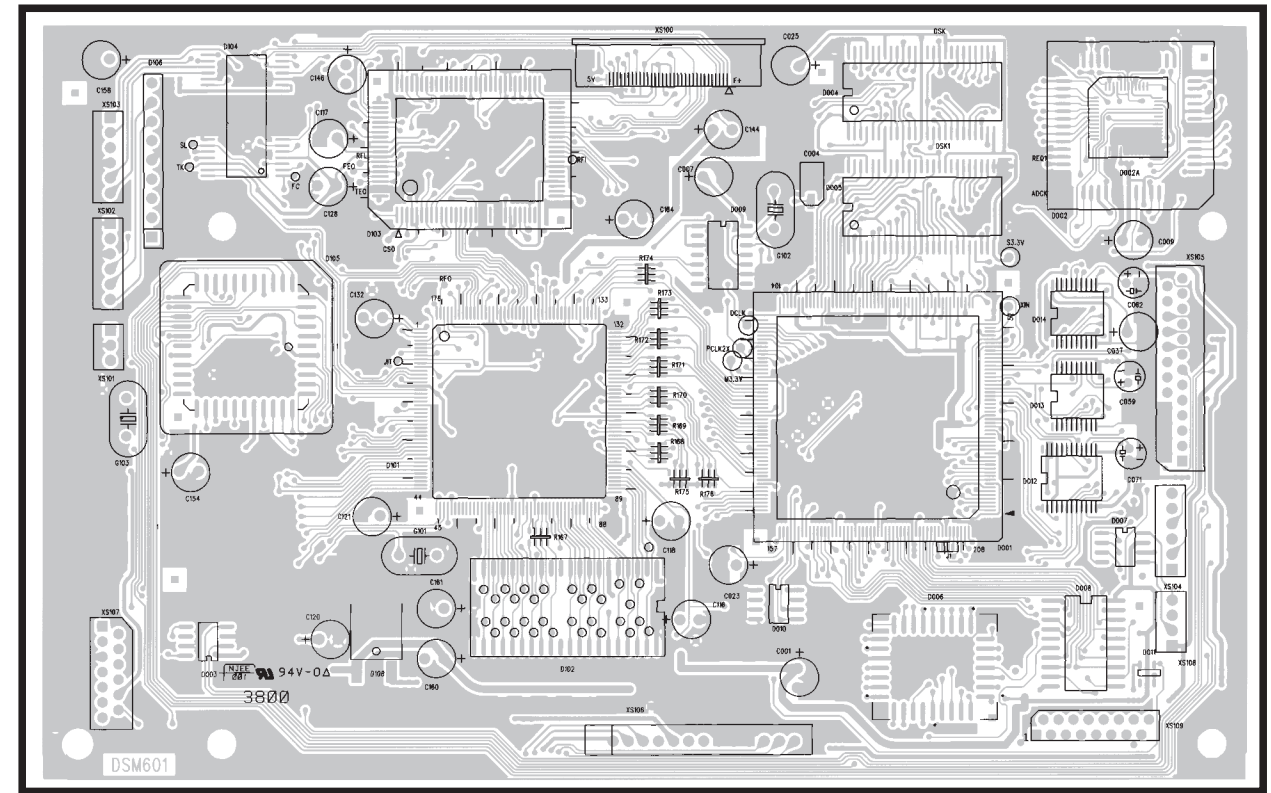
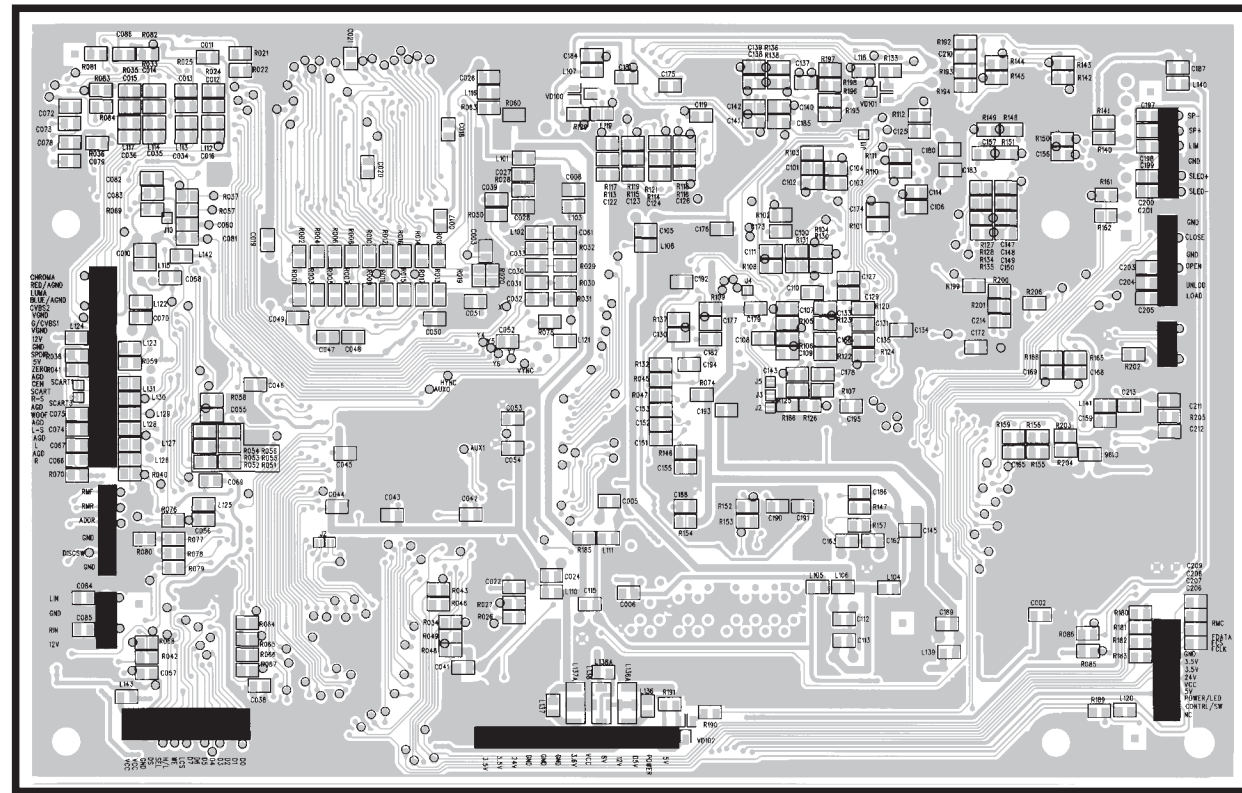

DSM6012BM MAIN BOARD

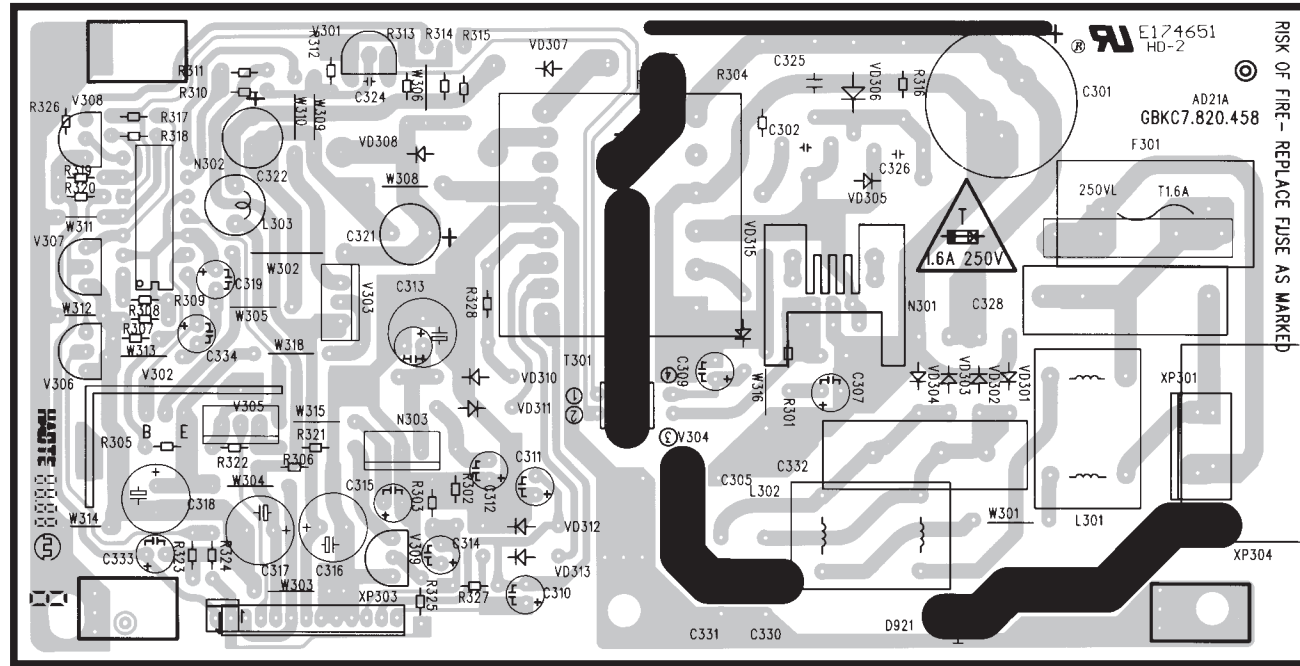

AD21POWER BOARD

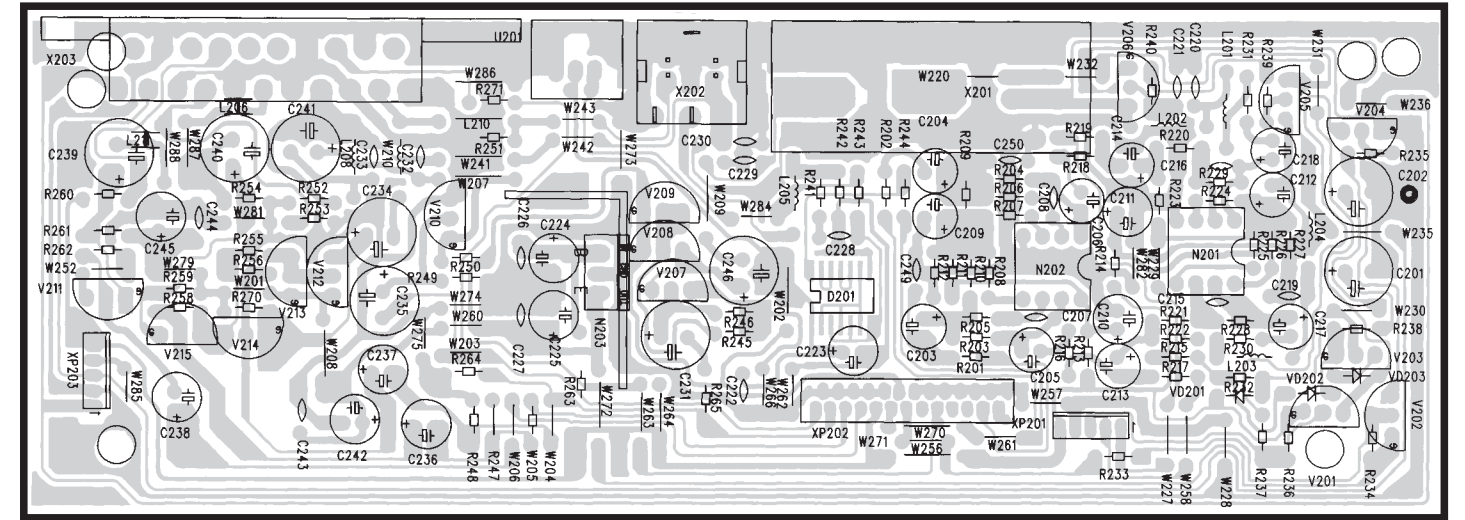

SCART-868-312P OUTPUT BOARD

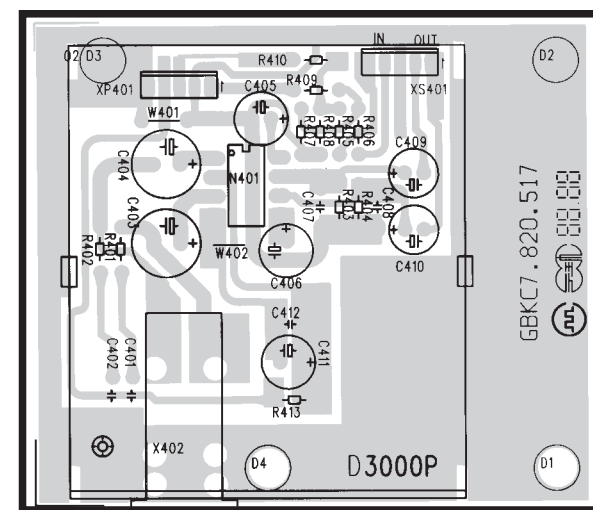

D3000P BOARD

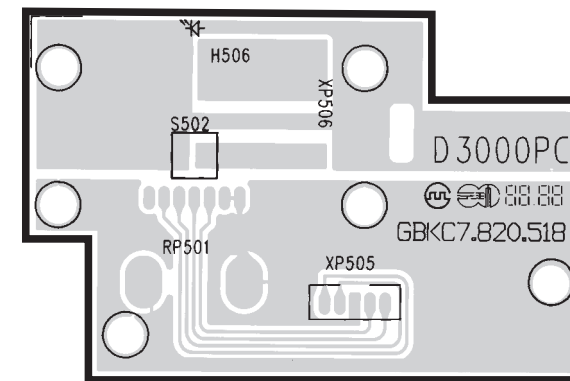

D3100PC BOARD

TEAC DV-3000

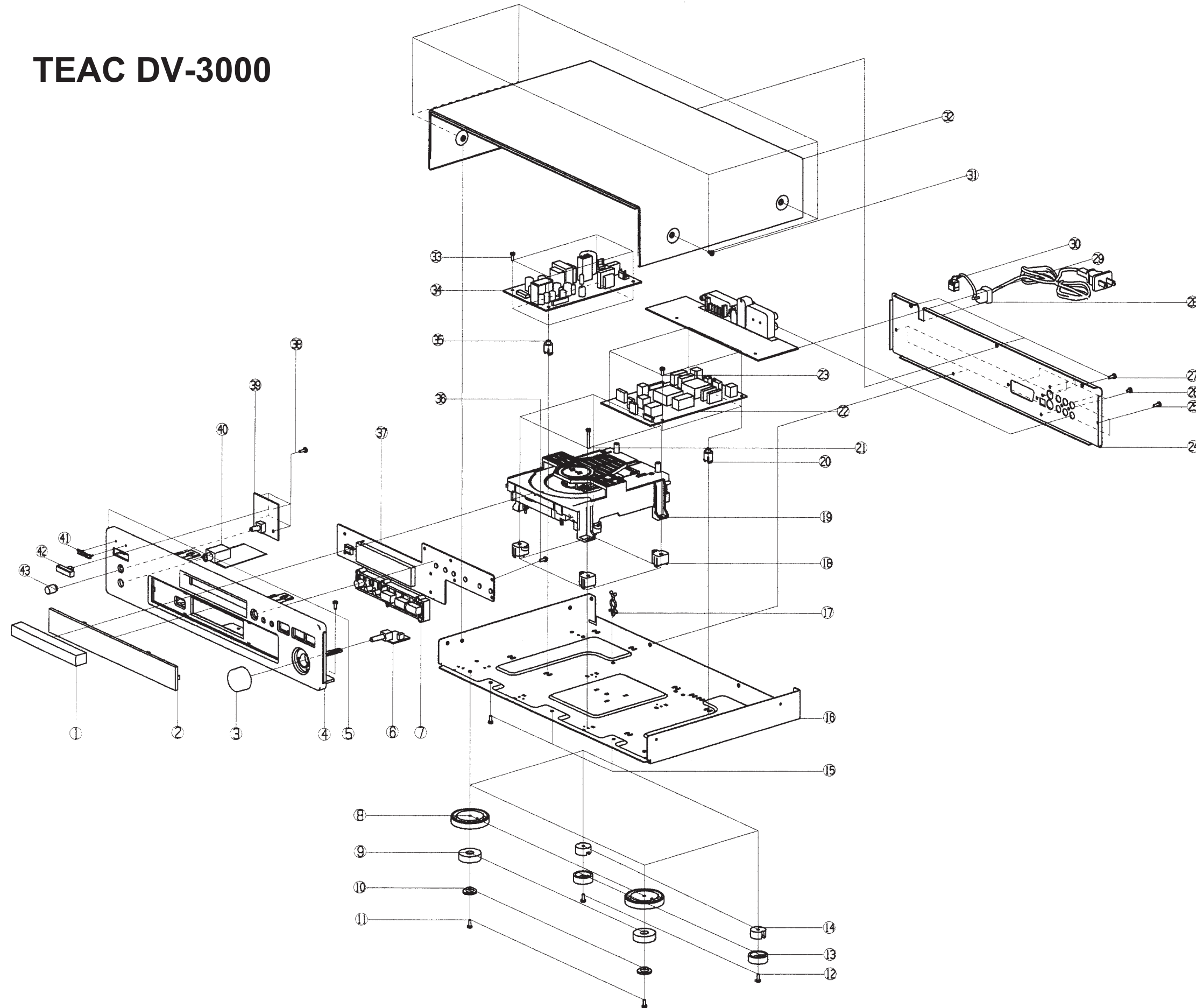

No.	PARTS No.	PARTS NAME
1	b6032U	DOOR
2	b6038	TRANSPARENT WINDOW
3	b6036H	KNOB
4	b6031U	FRONT PANEL
5	a2793	SCREW M3×6
6		SEARCH SWITCH UNIT
7	b6035H	FUNCTION BUTTON
8	b6033	FOOT D
9	b1633	FOOT SPACER A
10	b1632	FOOT SPACER
11	a2766	SCREW ST3×12
12	a2765	SCREW ST3×10
13	b3019	FOOT B1
14	b3020	FOOT SPACER A1
15	a2793	SCREW M3×6
16	b6027	CHASSIS
17	b3183	WIRE CLIP
18	b6041	MECHANISM SPACER
19	S2277	MECHANISM UNIT
20	b3127	PCB SPACER
21	a2776	SCREW ST3×18
22	0817	MAIN UNIT
23	a2779	SCREW ST3×14
24	b6030	REAR PANEL
25	a2794	SCREW M3×8
26	a2750	SCREW ST3×8
27	a2761	SCREW ST3×6
28	S3024	POWER CORD HOLE
29	S7000	OUTPUT UNIT
30	S2672	POWER CORD
31	a2761	SCREW ST3×6
32	b6029H	TOP PANEL
33	a2777	SCREW ST3×20
34	S2177	POWER UNIT
35	b1626	SPACER
36	a2773	SCREW ST3×8FT
37	0813	KEY UNIT
38	a2794	SCREW M3×8
39	0815	POWER BUTTON UNIT
40	S7019	PHONE UNIT
41		TEAC CHARACTER
42	b6034H	POWER BUTTON
43	b6037H	ECHO KNOB

EXPLODED VIEW LIST

REF. NO.	PARTS NO.	DESCRIPTION	REMARKS
1	9A08793700	DOOR	B6032U
2	9A08786200	TRANSPARENT WINDOW	B6038
3	9A08793800	KNOB	B6036H
4	9A08793900	FRONT PANEL	B6031U
5	9A08619000	SCREW, M3X6	A2793
6	-----	SEARCH SWITCH UNIT	
7	9A08794000	FUNCTION BUTTON	B6035H
8	9A08786600	FOOT D	B6033
9	9A08619600	FOOT SPACER A	B1633
10	9A08619500	FOOT SPACER	B1632
11	9A08786700	SCREW, ST3X12	A2766
12	9A08619400	SCREW, ST3X10	A2765
13	9A08786800	FOOT B1	B3019
14	9A08786900	FOOT SPACER A1	B3020
15	9A08619000	SCREW, M3X6	A2793
16	9A08787000	CHASSIS	B6027
17	9A08621500	WIRE CLIP	B3183
18	9A08787100	MECHANISM SPACER	B6041
19	9A08763400	MECHANISM UNIT, KHL-231A2M	S2277
20	9A08787200	PCB SPACER	B3127
21	9A08621200	SCREW, ST3X18	A2776
22	9A08763500	MAIN UNIT	0817
23	9A08787300	SCREW, ST3X14	A2779
24	9A08795000	REAR PANEL	B6030
25	9A08619900	SCREW, M3X8	A2794
26	9A08620700	SCREW, ST3X8	A2750
27	9A08621000	SCREW, ST3X6	A2761
28	△ 9A08620800	POWER CORD HOLE	S3024
29	9A08767620	OUTPUT UNIT	S7000
30	△ 9A08764800	POWER CORD	S2672
31	9A08621000	SCREW, ST3X6	A2761
32	9A08781900	TOP PANEL	B6029H
33	9A08787600	SCREW, ST3X20	A2777
34	9A08767710	POWER UNIT	S2177
35	9A08787700	SPACER	B1626
36	9A08622000	SCREW, ST3X8FT	A2773
37	9A08763600	KEY UNIT	0813
38	9A08619900	SCREW, M3X8	A2794
39	9A08765000	POWER BUTTON UNIT	0815
40	9A08767820	PHONE UNIT	S7019
41	-----	TEAC CHARACTER	
42	9A08794500	POWER BUTTON	B6034H
43	9A08794600	ECHO KNOB	B6037H

INCLUDED ACCESSORIES

REF. NO.	PARTS NO.	DESCRIPTION	REMARKS
	9A08764000	OWNER'S MANUAL	S1003
	9A08764100	RCA CORD, AV	S2655
	9A08764600	REMOTE CONTROL UNIT, RC-805	S0670
	9A08764700	BATTERY	S2708

KEY UNIT

REF. NO.	PARTS NO.	DESCRIPTION
	9A08763600	KEY UNIT
D501	9A08655600	UPD16311
PH501	9A08655700	FABSE1252
RP001	9A08662500	KHX3-3W1D
S501-S506	9A08655400	EVQ20504M
U501	9A08655500	HS0038
V501	9A08654000	TR, C8050
VD501-503	9A08653800	DIODE, 1N4148
VED501	9A08655300	VFD25-0705
XP001	9A08662600	B-3B-PH

POWER UNIT

REF. NO.	PARTS NO.	DESCRIPTION
	9A08767710	POWER UNIT
	9A08766900	FUSE HOLDER
C301	△ 9A08650000	C, 450V 68U +-20%
C302	9A08648300	C, 1KV 470K
C305	△ 9A08648500	C, AC400V 222M
C328	△ 9A08648800	C, 280VAC 0.22M
C330, C331	△ 9A08648400	C, AC400V 471K
C332	△ 9A08648700	C, 280VAC 0.01K
F301	△ 9A08650800	FUSE, T1.6A/250V
L301	△ 9A08650500	INDUCTOR, POWER FILIER
L302	△ 9A08650600	INDUCTOR, VF2327L-253YOR
L303	9A08650300	INDUCTOR, COIL-0.02MH
N301	9A08645400	TR, TOP223Y
N302	9A08645500	IC, LM324
N303	9A08633400	TR, KA7812
R304	△ 9A08647400	R, 3W 2.2K +-5%
T301	△ 9A08650700	TRANSFORMER, BCK-R800A
V301	9A08650100	TR, KA4311Z
V302, V303	9A08645700	TR, 3DA3852
V304	△ 9A08650200	TR, PC123
V305	9A08766800	TR, 2SB772
V306, V307	9A08661800	TR, 9014C
V308	9A08654000	TR, C8050
V309	9A08654000	TR, C8050
VD301-304	△ 9A08785900	DIODE, 1N4007
VD305	△ 9A08647600	DIODE, RU-1P
VD306	9A08647700	DIODE, P6KE200
VD307	9A08648000	DIODE, RU2YX
VD308	9A08766500	DIODE, 31DQ06
VD310	9A08766600	DIODE, 11EFS2
VD311, 313	9A08786000	DIODE, 10ELS4
VD315	9A08786000	DIODE, 10ELS4
XP301	9A08650900	SOCKET, 3951P03V
XP303	9A08767000	DC POWER CORD
XP305	9A08767100	B-2B-PH

OUTPUT UNIT

REF. NO.	PARTS NO.	DESCRIPTION
	9A08767620	OUTPUT UNIT
D201	9A08767300	IC, 74HCU04A
L201-L205	9A08661700	INDUCTOR, 3.3UH
L206	9A08653700	INDUCTOR, BGH2012B601
L208	9A08661600	INDUCTOR, 1.8UH
L211, L212	9A08653700	INDUCTOR, BGH2012B601
N201, N202	9A08654200	IC, AN4558
N203	9A08654300	IC, CW7805
R263	△ 9A08652200	R, 1W 15 +-5%
R271	9A08661700	INDUCTOR, 3.3UH
U201	9A08767400	IC, TOTX178A
V201-V203	9A08653900	TR, 8550D
V204-V206	9A08654000	TR, C8050
V207-V215	9A08653900	TR, 8550D
VD201-203	9A08653800	DIODE, 1N4148
W287, W288	9A08661700	INDUCTOR, 3.3UH
X201	9A08654500	JACK
X202	9A08654600	SOCKET
X203	9A08654700	JACK
XP202	9A08654900	52806-2510
XP203	9A08654800	B-5B-PH

PHONE UNIT

REF. NO.	PARTS NO.	DESCRIPTION
	9A08767820	PHONE UNIT
N401	9A08656300	IC, D2822
X401	9A08765500	MIC JACK
XS401	9A08654800	B-5B-PH

POWER BUTTON UNIT

REF. NO.	PARTS NO.	DESCRIPTION
	9A08765000	POWER BUTTON UNIT
H506	9A08765700	LED, 1X3.5 RED
J5	9A08765900	WH142A-1-50KC-15-5
S502	9A08655400	EVQ20504M